13.56 MHz RFID Power System

Darren Pluth
Gurveer Singh
Li-Cheng Shiue
Geetpal Kaur

Advisor: Dr. Raymond Kwok

May 14, 2004



Table of Contents

1. Abstract
2. RFID History
3. RFID System
4. Project Introduction
5. Oscillator
6. Amplifier
7. Antenna
8. Reference

Abstract

The RF power system consists of oscillator, amplifier, and Helmholtz antenna. The report focuses on how low powered, low frequency RFID reader is able to detect and identify the RF Tag at a greater distance with the assistance of the RF power system. Since the available RFID Reader is a low power and low frequency device, it in coordination with oscillator - providing constant sine wave at a specified frequency, amplifier – amplifying the signal, and Helmholtz antenna – providing uniform magnetic field between the two coiled loops is a successful RF power system. It includes corresponding schematics from PSPICE for oscillator and amplifier with the results/outputs obtained from oscilloscope.

RFID History

RFID time development started in the 1940's and was referred to as "reflected power communication." During that progress was slow in the design because key technologies were not available yet such as the transistor, integrated circuit, and microprocessor. Most of the RFID concentration from 1950 to 1980 was based on laboratory experiments at Universitys, and government labs. The United States Government gave funding to Los Alamos National Laboratories to further the development of the technology in the early 1980's. During this time the previously stated technologies were mature enough to support RFID's full potential. The 1980's saw commercialization of the technology on a small scale; this was because the technology was so expensive.

The focus of RFID in the United States during the 1980's was on transportation, personal access and for animal tracking. These beginning industries were the paving stones for the explosion of the technology in the 1990's. During this decade the technology was used by the US military in tracking cargo that the Airforce and Army shipped. The technology was also implemeted on the Bay Bridge in Oakland to allow commuters high speed access through the toll gates. The largest development in this decade is now Walmarts commitment to have RFID take over barcode scanning completley and automate their purchasing system. This is a large step because Walmart is the largest retailer in the world. The timeline below shows how RFID was used around the world based on each decade.

- 1940s -- RFID used in WW2 to identify 'friend or foe' aircraft
- 1960s -- Electronic article surveillance used to counter theft – first commercial use of RFID
- 1970s -- Developers, inventors, companies, academic institutions and government develop RFID applications
- 1980s -- Europe deploys RFID for animal tracking, industrial and business applications and payment on toll roads
- 1996 -- ANA (e.centre) board and EAN International plan RFID as the next standard data carrier
- 1998 EAN UCC RFID project kicks-off
- 1999 -- EAN and UCC adopt UHF the Auto-ID Center is established to develop the 'internet of things'
- 2000 -- EAN UCC rolls out the GTAG project
- 2002 -- E.centre leads the Home Office Chipping of Goods 'CD.id' project
- 2003 -- EPCglobal joint venture set-up to oversee the rollout of RFID standards worldwide
- 2004 -- First EPCglobal standards are released

RFID System

RFID is a mix of Electrical Engineering disciplines to transmit digital data through wireless transmission. The system contains three elements which are the RFID reader/transmitter, the reader's antenna, and the transponder. The reader/transceiver is a device that generates the digital pulse code required to activate the transponder. The transceiver also designates what frequency the system will operate at. The RFID system chosen for this project is Skyetek's M1 which has a frequency of 13.56 MHz. Based on other industry models which are 915 MHz, 13.56 MHz is low. Since the frequency used for this project is low, that means that the power associated with the wave is low and the reading range will be short.

The second part of the RFID system is the transponder, which has two different power supplies. The transponder in the system used for this project is the passive type. This means that the transponder tag uses the energy from the transceivers transmitted

wave to send its coded information. The other version of the transponder is the more costly battery powered version. This device will transmit the information for up to 4 weeks and will have a range of 30 meters.

Antenna's used in RFID systems are based on the needs of the customer and can range anywhere from Helmholtz to Dish style. Skyteks RFID transceiver has a built in antenna that is in the shape of a loop. It has a radius of about $\frac{3}{4}$ of an inch and only one turn. The transceivers default setting is the on board antenna, but an external antenna can be installed with the change of a jumper setting on the circuit board.

Figure1 shows what the RFID transceiver looks like.

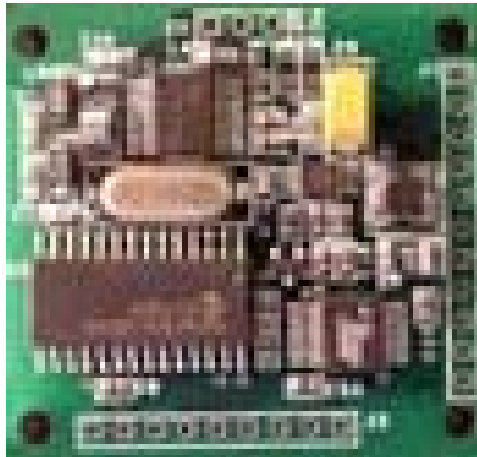

Figure 1

Project Introduction

The reading range of a 13.56 MHz RFID system is around 3cm with passive tags. In order to increase the distance to a more usable range, an amplification system needs to be built. The chosen system is a wireless power transfer system. The system is designed to transmit an amplified sine wave at 13.56 MHz to the transponder. This will theoretically allow the transponder have enough available energy to send its coded information a distance farther than 3 cm. The power that is transmitted is a generic signal that places the transponder in an amplified standby state. When the transceiver sends its information to the transponder it turns on and transmits the bits programmed into it. It has the power of both the generic signal and the transceivers. Figure 2 shows how the RFID and the wireless power amplifier system will interact with each other.

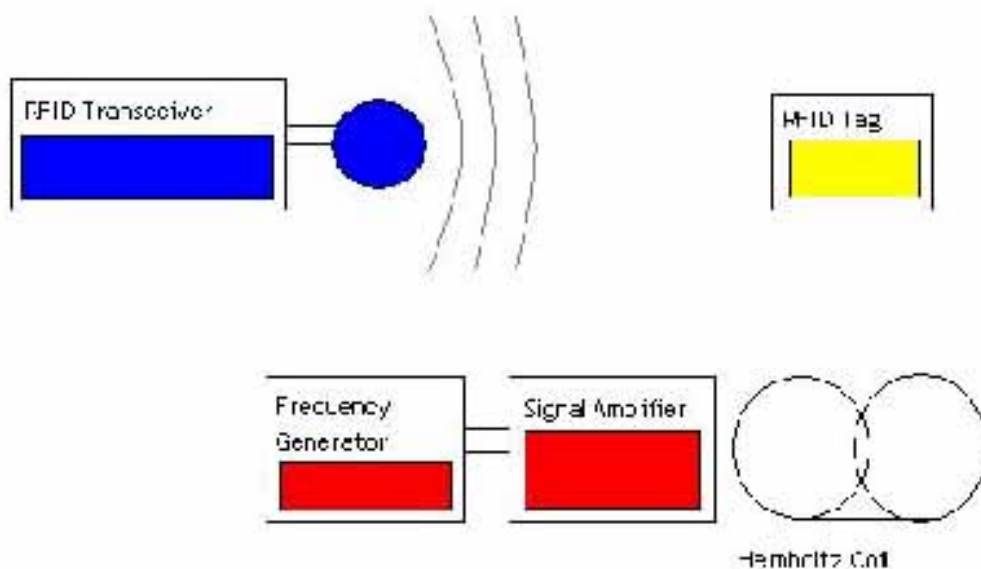

Figure 2

A schematic of the oscillator circuit cannot truly represent the beauty and awe inspiring feeling one gets from seeing it in real life, so the real circuit is given in figure 4.

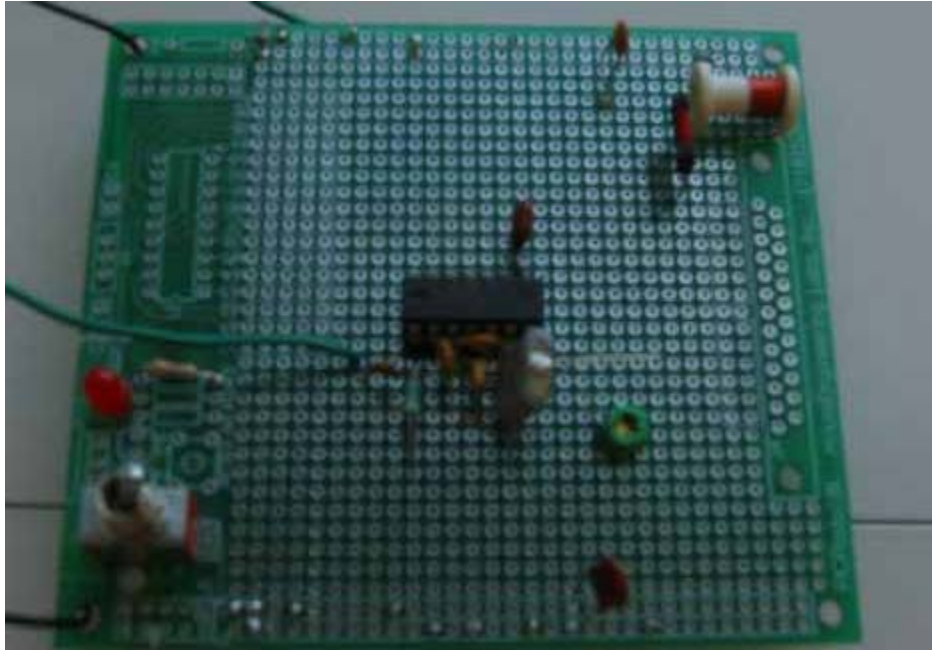

Figure 4

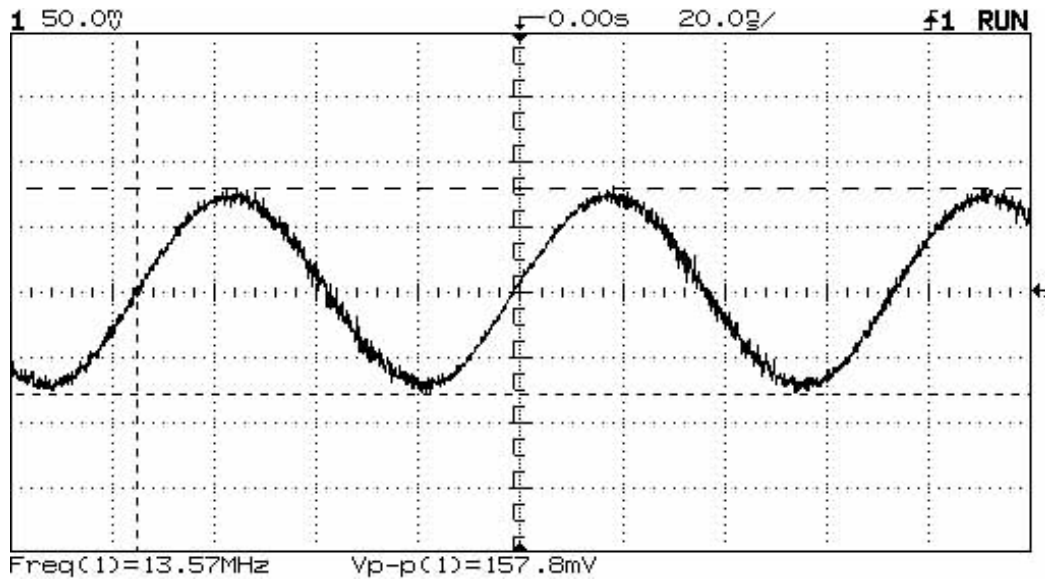

Figure 5

Amplifier

Amplifier is one of the major components of RF power system. First the amplifier circuit was designed and simulated on PSPICE as shown in Figure 6. Once the satisfactory result was obtained then the circuit was built on the breadboard using 2N2222A transistor and tested for consistency with the PSPICE results. Finally, all the components were soldered on the PCB and tested.

The frequency response is shown in Figure 7 and from this cutoff frequency was estimated to 17.581MHz. Figure 8 shows the input and output signals as displayed on oscilloscope. The top curve is input signal and the bottom curve is the amplified output signal. The gain was calculated from this figure, and it is $V_o/V_i \sim 5.53 \text{ V/V} \sim 14.85 \text{ dB}$.

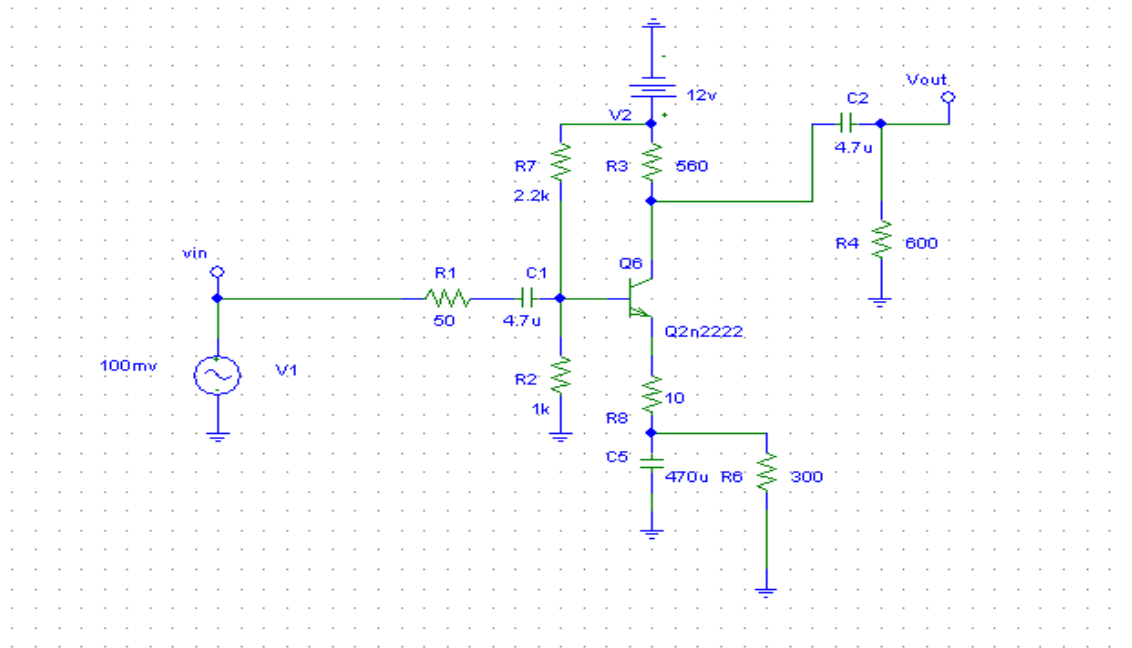

Figure 6

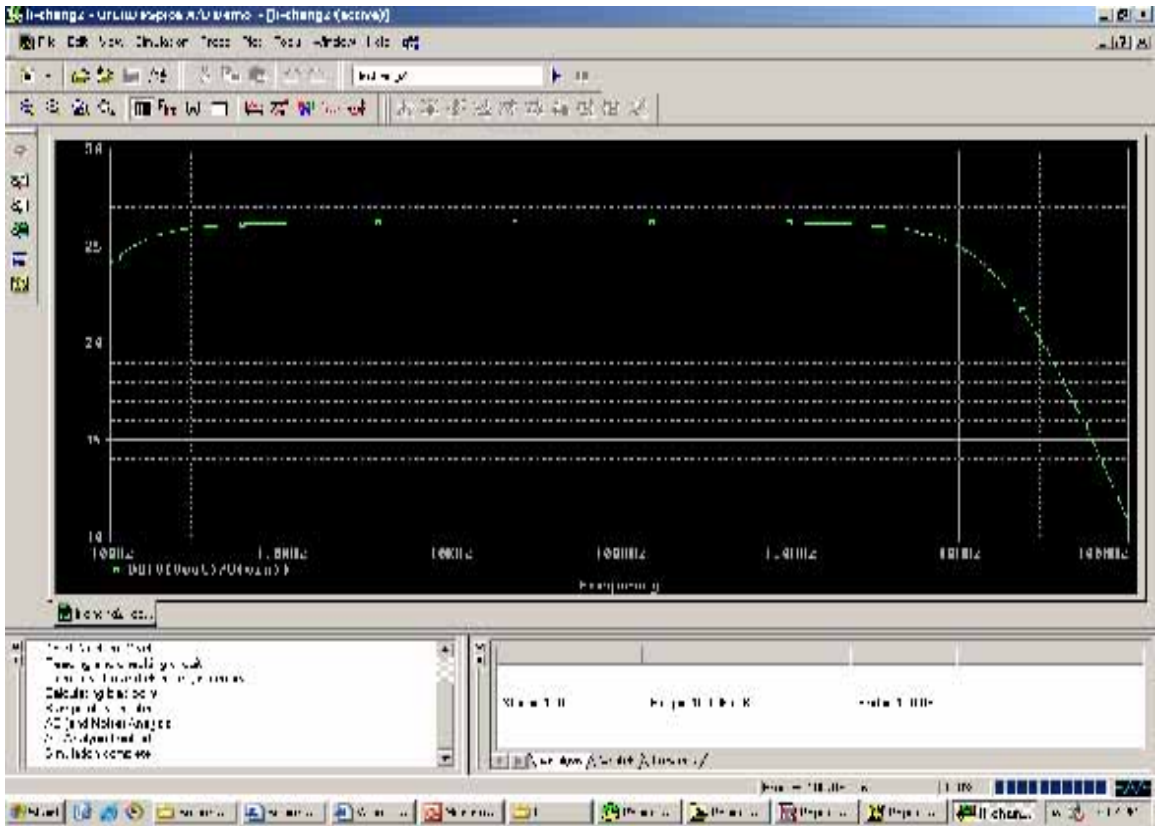

Figure 7

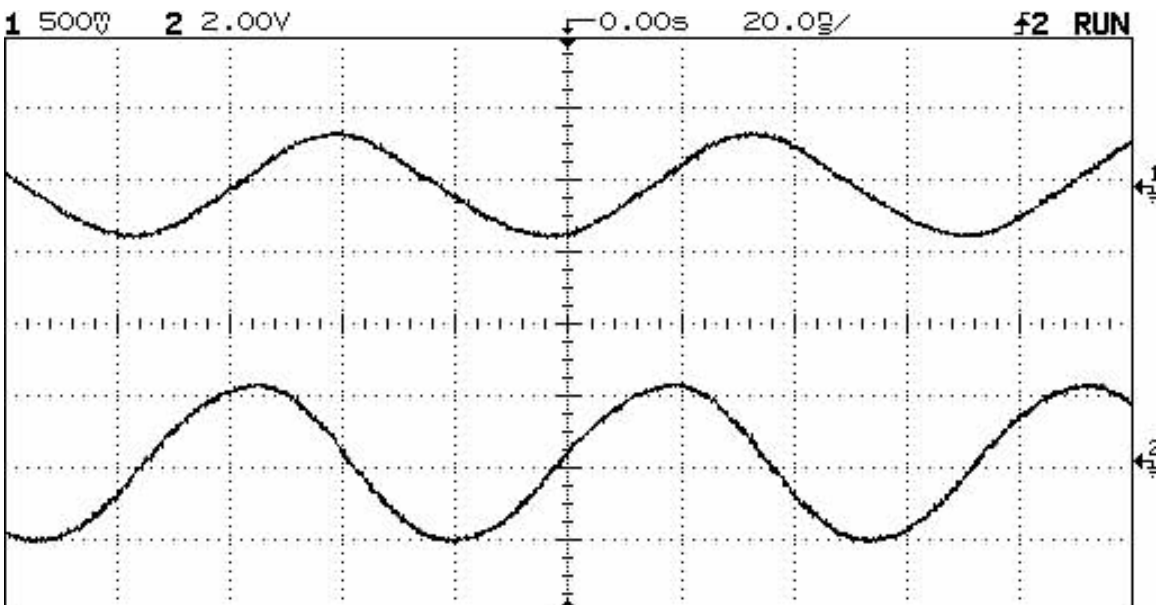

Figure 8

Antenna

To create a stronger and more uniform magnetic field, Helmholtz coil configuration is used for Antenna. Helmholtz Coils consist two circular rings of wire parallel to each other on a common z axis. These rings have radius R and they are separated by a distance R . These rings carry equal currents in the same direction. To find the magnetic field generated by a pair of Helmholtz coils, It is assumed that the coils are centered at $z = 0$ and at $z = R$.

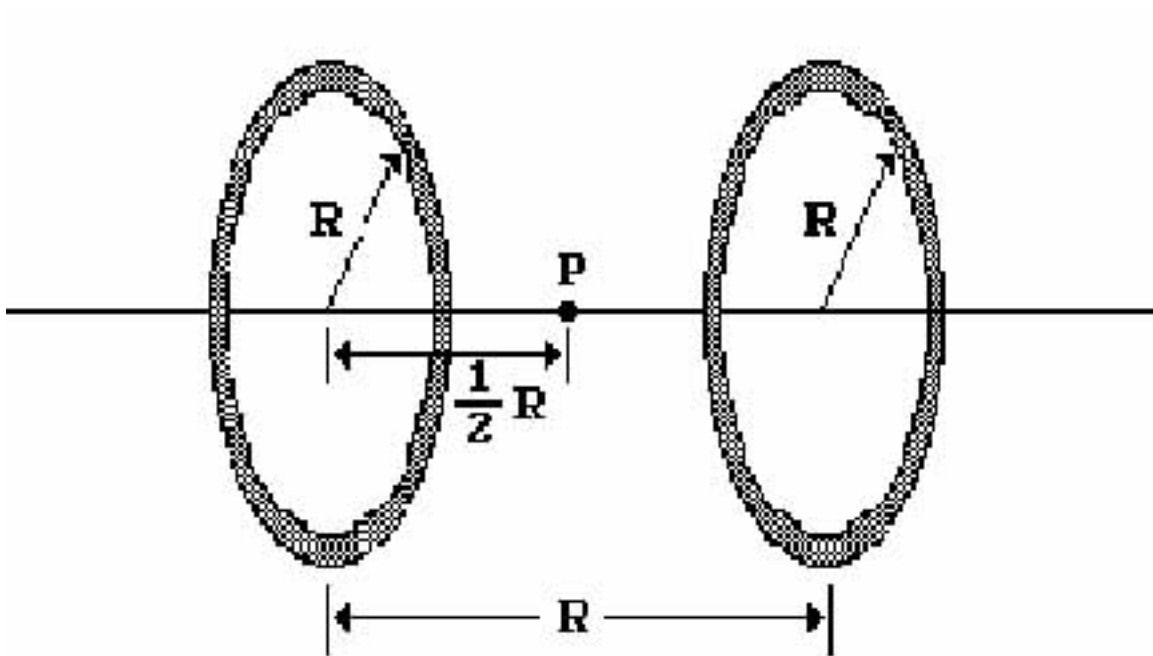
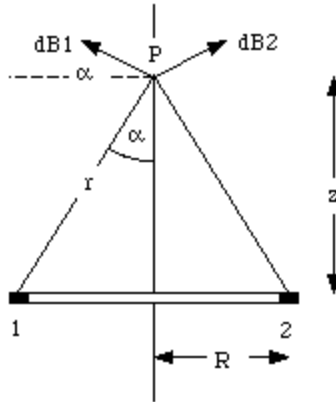

Figure 9

Magnetic field of one coil is found first:



**Magnetic field produced by one ring
Figure 10**

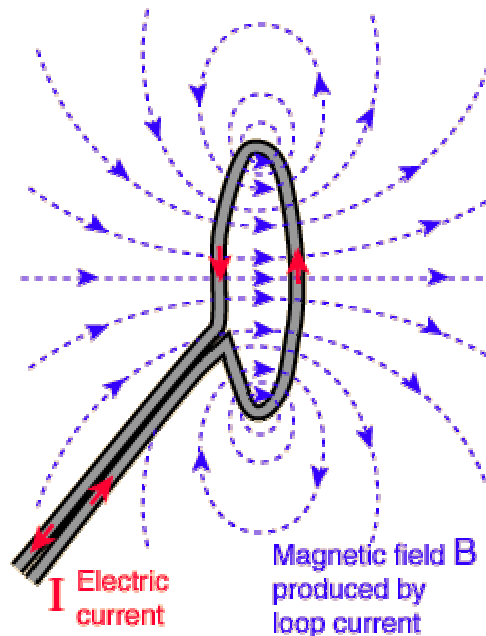

Figure 11

The ring is located in the x-y plane and the field is at point P, a distance z is above the x-y plane. The net magnetic field of the ring at point P will be directed along the z-axis. The magnitude dB of the magnetic field produced by a small segment of the ring with length dL is equal to

$$dB = \frac{\mu_0}{4\pi} I \frac{dL}{r^2}$$

Magnetic field generated by one coil located at $z = 0$ is:

$$B = \frac{\mu_0}{4\pi} I \frac{R (2\pi R)}{(R^2 + z^2)^{3/2}} = \frac{\mu_0}{2} \frac{I R^2}{(R^2 + z^2)^{3/2}}$$

The magnetic field generated by the coil located at $z = R$ is:

$$B = \frac{\mu_0}{2} \frac{I R^2}{(R^2 + (z - R)^2)^{3/2}}$$

The total field on the axis of a pair of Helmholtz coils is equal to the sum of the field generated by coil 1 and the field generated by coil 2:

$$B = \frac{\mu_0}{2} I R^2 \left(\frac{1}{(R^2 + (z - R)^2)^{3/2}} + \frac{1}{(R^2 + z^2)^{3/2}} \right)$$

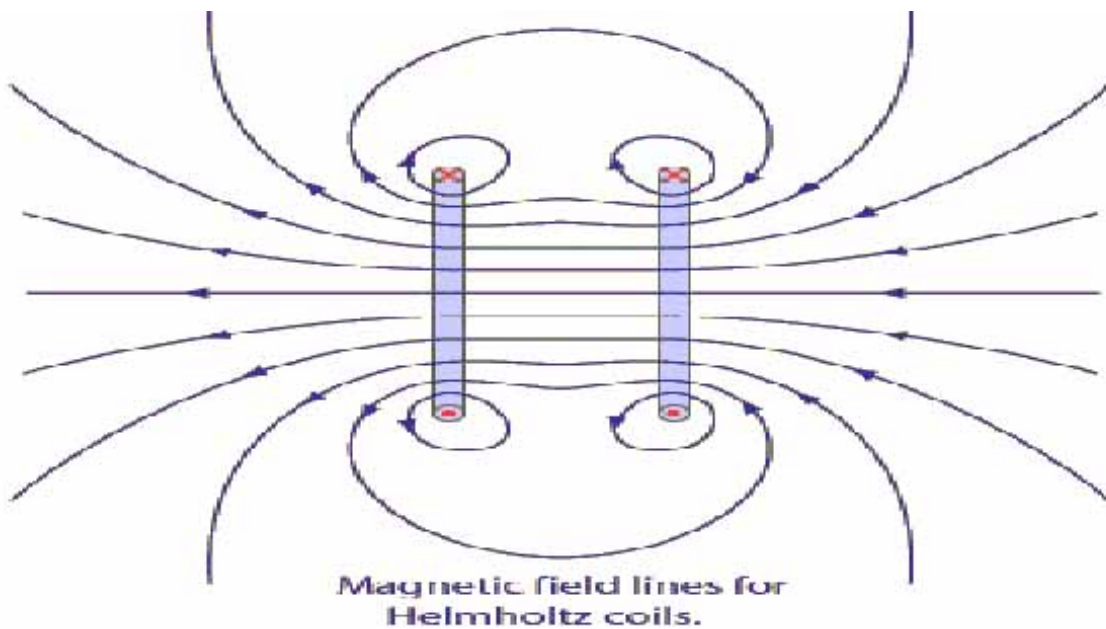

Figure 12

Conclusion

This project has taught us a lot about RF technology and offered us the opportunity to explore and design RF circuits.

Despite the problems encountered with the preliminary design approaches, the RF power system was successfully completed using an extremely challenging design approach.

Completion of this project is a low powered, low frequency, less expensive system that is capable of detecting RF tag from a greater distance. It required us to involve in a broad research on the topic of RF. Estimated cost of this project was approximately \$172; however, the actual cost of this project is \$457.

The oscillator circuit when connected to the amplifier reliably produces a gain of 14.68dB. The Range of frequency transmitted by the amplifier varies 13.4-13.7 MHz. The amplified signal could not be stabilized at 13.56 MHz. This results in the antenna not being able to transmit consistent RF power at 13.56MHz, which is required by the tag to be activated.

References

1. “History of RFID” May 12, 2004
<http://www.rfidsurvival.com/HistoryofRFID.html>
2. **Microelectronics Circuits**, by Sedra/Smith, 4th Edition, 1998 Oxford University Press
3. “Physics 122 Lecture Notes”
<http://www.teacher.nsr1.rochester.edu/phy122/lecturenotes/chapter30/html>