

YIG Oscillator

Donald Benson, Ali Tatari, Amaaduddin, San Jose State University Fall 2009, EE 172

Abstract –A resonator based on YIG (Yttrium Iron Garnet) and a bipolar amplifier were implemented, targeting application as an oscillator in the < 6 GHz range. Undesired resonances from parasitic elements were noted in simulations and observed in measurement. Inadequate magnetic field strength prevented proper operation of the YIG element. A second implementation of the amplifier improved amplifier performance, and improved magnetic pole pieces concentrated the field so tuning from 1.8 GHz to 6 GHz was observed. Improvements for future work were identified

I. INTRODUCTION

This project began as development of a YIG based oscillator. The frequency range of up to 6 GHz was selected based on lab equipment available to students at SJSU.

It was decided to make a YIG resonator and an amplifier as separate circuits with RF connectors. This allowed the team to work on them independently, characterize them, simulate how they would work together, and then test as an assembly.

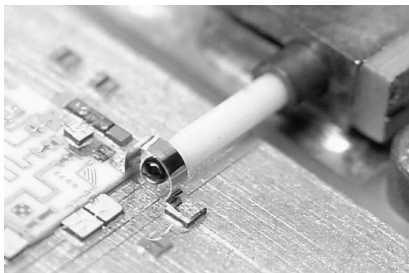

Fig I 1 : A commercial YIG oscillator

Photo from <http://www.vhfcomm.co.uk/pdf/A%20Simple%20Approach%20to%20YIG%20Oscil.pdf>

A. Background

YIG (Yttrium Iron Garnet) is grown as a crystal, diced into cubes, and polished in a tumbler to form spheres. It serves as a ferro-magnetic material, and the precession of “spinning” electrons resonates at a frequency proportional to an externally applied magnetic field when excited in a different direction by an RF field.

YIG provides stable, tunable frequency references in the GHz range. It is slower than Varactor-diode tuned VCOs due to the inductance of the electromagnet’s coil. As with crystal oscillators, temperature compensation (a regulated heater) can be used to eliminate frequency variation due to ambient temperature and self heating.

According to the website for Microlambda Wireless, a manufacturer of YIG oscillators and filters,

<http://www.microlambdawireless.com/apppdfs/ytodefinitions2.pdf>

“Phase noise is energy generated at frequencies other than the carrier/center frequency. Phase noise is measured as power relative to the carrier/center frequency, in frequency “windows” offset from the carrier/center frequency.”

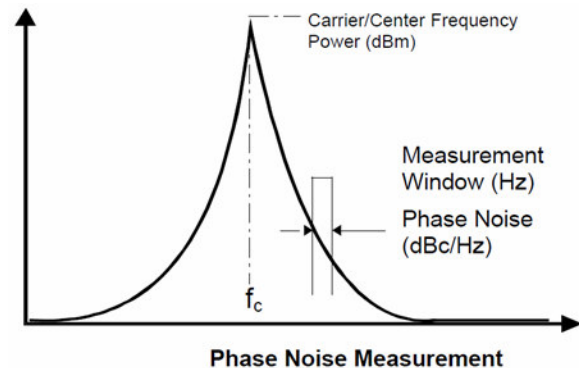

Fig I 2 : Phase noise measurement

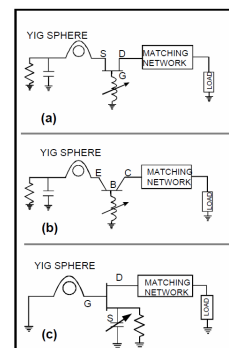

Fig I 3 : Common circuit types

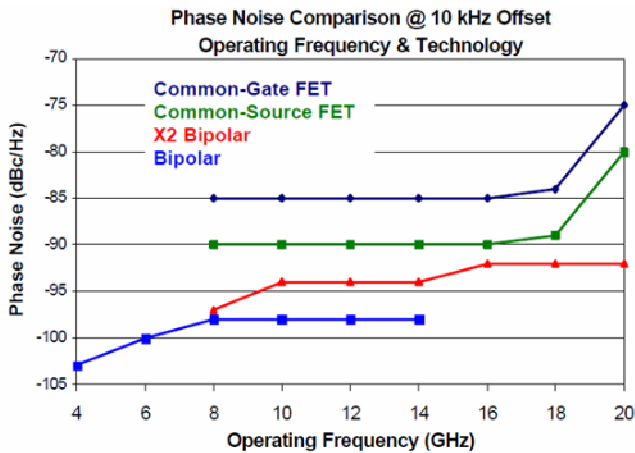

Fig I 3 : Comparison of circuit types

(the preceding pictures were all from Microlambda Wireless)

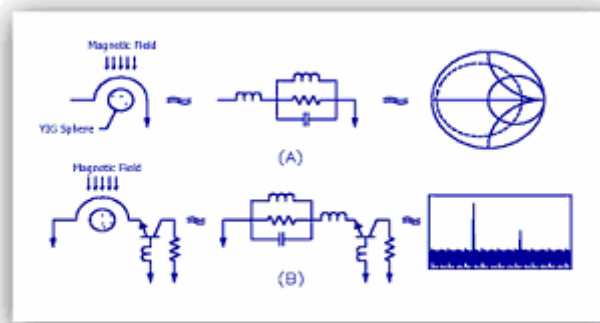

Figure 1

Fig I 4 : alternate common—base configuration with no physical capacitors, just parasitic C & R in equivalent circuit

http://www.teledynemicrowave.com/Products/Oscillators/Ultra_Low_Phase_Noise_YIG_Oscillators.aspx

YIG spheres can also be used to create filters.

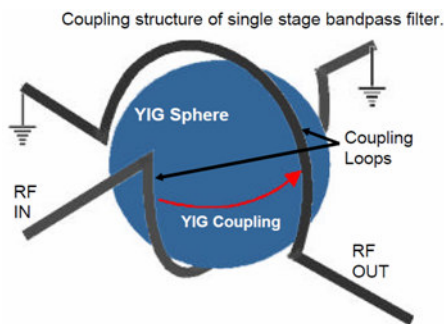

Fig I 5 : Diagram of YIG-coupled loop filter

Picture from <http://www.microlambdawireless.com/apppdfs/ytfodefinitions2.pdf>

Note that all power will pass through this 0.012” sphere!

“The coupling loops are essentially RF transmission lines that pass all RF energy. However, when these transmission lines are located close to the surface of the YIG sphere, the loop couples to the magnetic field resonating (@ microwave frequencies) around the YIG sphere. This coupling essentially reflects/rejects in coming frequencies that are at the same RF frequency as the RF magnetic field resonating around the YIG sphere. Rejection bandwidth is widened by increasing the number of YIG resonators and carefully “tuning” the RF coupling loops.”

Limitations of YIG include power consumption (driving the coil) and slower tuning than oscillators with varactor diodes, due to the time required to change current through an inductor, and limited frequency response of magnetic cores. The former is sometimes addressed with two coils, one for coarse range setting, and the other for closed-loop control. One area of current research is combination with piezo devices to allow rapid frequency tuning by application of mechanical stress. This was proposed for use in phased array applications, where the speed of sweeping an antenna beam depends on the rate at which phase shifters can be tuned.

B. Advantages of YIG

YIG oscillators have good signal quality with low level of phase jitter as compared to VCOs. They also have better broad band characteristics. They have a linear tuning curve.

Low Phase Noise: According to Teledynewireless.com, http://www.teledynewireless.com/Products/Oscillators/Ultra_Low_Phase_Noise_YIG_Oscillators.aspx

“YIG Oscillators exploit the principle of magnetic resonance to generate a clean low phase noise microwave signal over broad tuning ranges.”

YIG behaves similar to a tank circuit when placed in the air gap of an electromagnet. It also experiences magnetic resonance which helps keep the phase noise low.

Wide Frequency range: YIGs come in different frequency ranges like 2 to 4 GHz, 4 -8 GHz, 8 – 12 GHz, 12 – 18 GHz , and 2 – 8 GHz. They can usually go beyond their specified range. For example , a 2 -4 GHz YIG can operate at 1.8- 1.9 GHz. Sometimes they can even go down into the megahertz

range. This all depends on the type of the YIG.
<http://www.vhfcomm.co.uk/pdf/A%20Simple%20Approach%20to%20YIG%20Oscil.pdf>

Wide Bandwidth Pulse Compression: YIGS can be used for wide bandwidth pulse compression. According IEEE proceedings, this was first demonstrated by Hughes in 1964 by successful compression of 90 MHz bandwidth frequency modulated pulse centered at 100 MHz.
<http://ieeexplore.ieee.org/stamp/stamp.jsp?arnumber=01446930>

II. FIRST IMPLEMENTATION

A. Amplifier

An amplifier circuit configuration was selected after reviewing literature. FET implementations support higher frequencies, but BJT covers the selected frequency range and offers improved phase noise, so this is the one that was pursued. Initial simulations were performed using a non-ideal Infineon transistor available in the Microwave Office library.

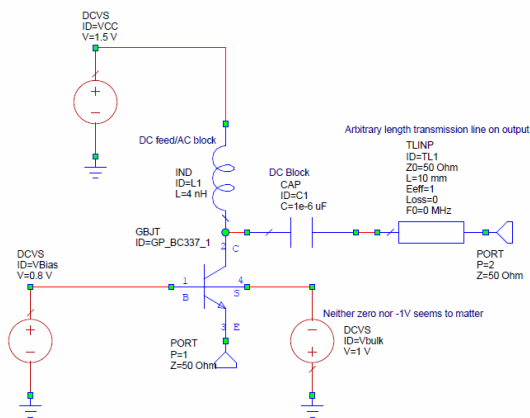

Fig II 1 : Diagram of Amplifier Circuit

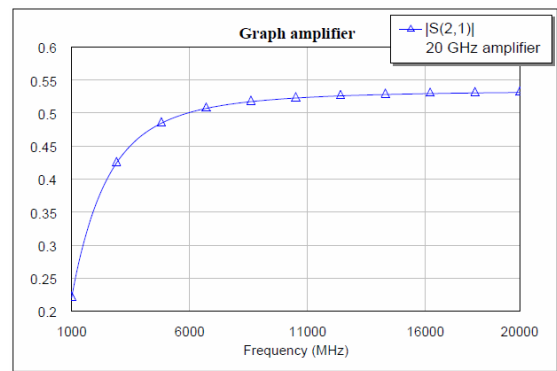

Fig II 2 : Simulated Amplifier Response

With no matching networks, a flat transfer function across the desired frequency range was observed, but with $S_{21} < 1.0$ it was not clear whether gain was achieved. If most of the incident energy was reflected due to impedance mismatch, an S_{21} less than one could still represent power gain. Calculations can be performed to determine gain, and this was done on other projects using Cadence Spectre RF to characterize very small FETs in a 50 ohm environment, but this approach was not tried this time.

An LC resonator was added to the circuit, and the simulated S-parameter port P1 was loosely coupled to it. The idea was to let the oscillator provide the power, but synchronized to the simulation frequency. In Cadence Spectre RF, this technique works when analyzing mixers with built-in oscillator, but the simulator has options to allow a transient simulation period to establish steady state conditions. In Microwave Office, a highly attenuated response was observed, suggesting that no positive gain or oscillation was achieved.

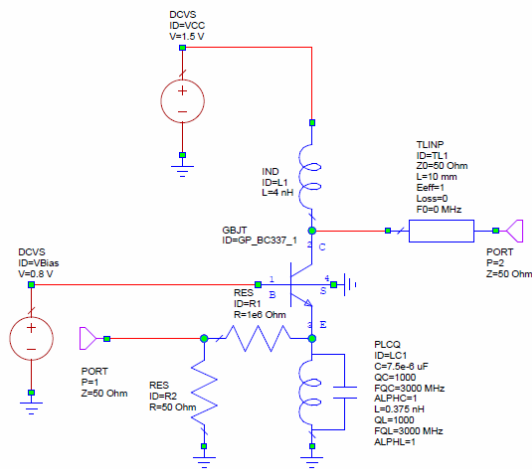

Fig II 3 : Diagram of Oscillator

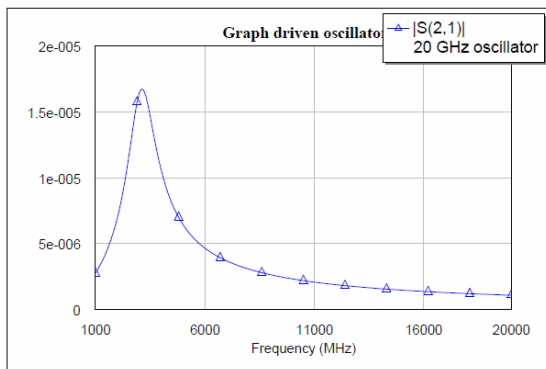

Fig II 4 : Simulated Oscillator Response

Further refinement of the amplifier circuit resulted in an S21 of +6dB, although in a fairly narrow peak at 1.6 GHz. This in fact turned out to be the frequency at which the “amplifier” oscillated, with no deliberately implemented resonator attached.

B. Resonator First attempt – cut transformer core

The initial resonator configuration chosen was a length of semi-rigid coaxial cable with an SMA connector. The cable was cut and the center conductor curled back to form a ½ turn inductor. For an electromagnet, the E-shaped core of a transformer core was cut so the magnetic field would have only one path to follow, and a 1/8” slot was made to provide an air gap. The ½ turn inductor was placed in the gap, and a YIG sphere (mounted on a ceramic rod for thermal control, packaged in a gel cap for shipping, and supplied by

Microsphere Inc.) was positioned inside it. This is configuration (c) in the reference circuits.

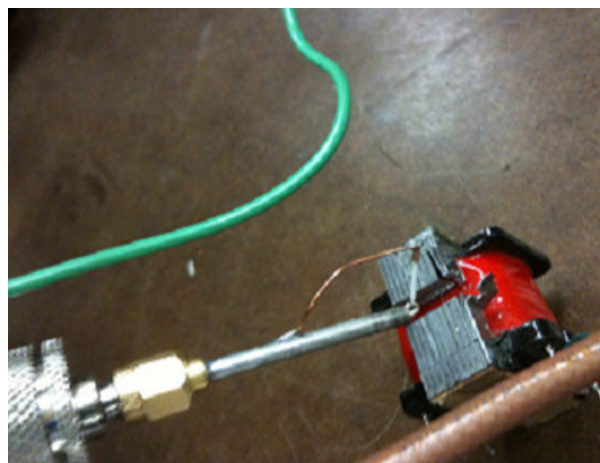
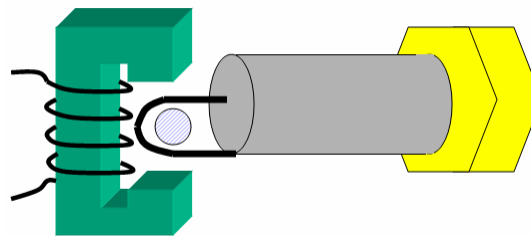

Fig II 5 : Diagram and Physical Implementation of YIG in Gap of Electromagnet

Only a slight reaction to coil current was observed on the VNA (Vector Network Analyzer). It was nothing that could be measured, just a slight shift in the trace. After re-calibrating, using the resonator as one of the calibration standards in an attempt to get a flat baseline response, only a slight amplitude variation was seen but no frequency tuning.

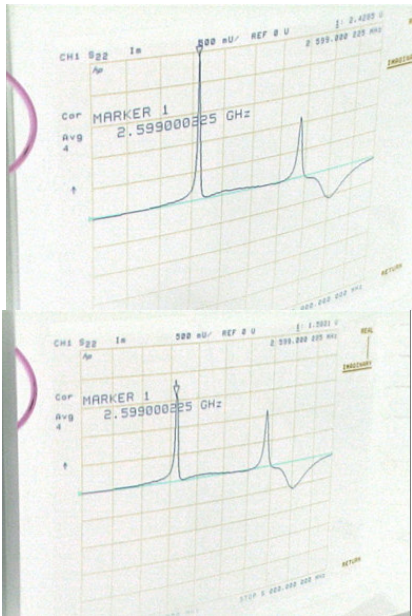

Fig II 6 : Screen shot of YIG response

Realizing that the difference between reflecting a signal back to the VNA (open) and connecting the signal through the YIG-tuned filter to ground (short) would just be phase, not much magnitude, another configuration, (b) was pursued. This was another suggested configuration for common-base BJT. Rather than connecting the inductor to ground, it goes to a capacitor to ground. In parallel with the capacitor is a resistor. When this circuit hits resonance, it dissipates more energy in the resistor. Off resonance, more energy will be reflected back to the source.

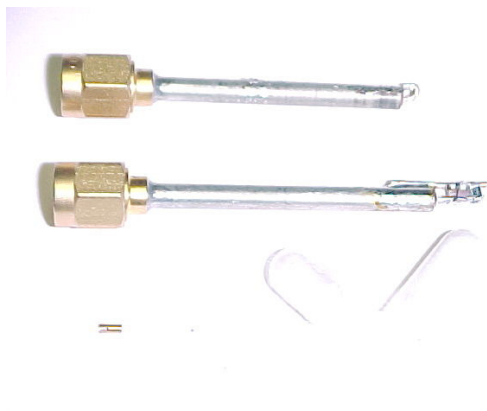

Fig II 7 : L resonator, RLC resonator, mounted YIG (barely visible) and gel cap packaging

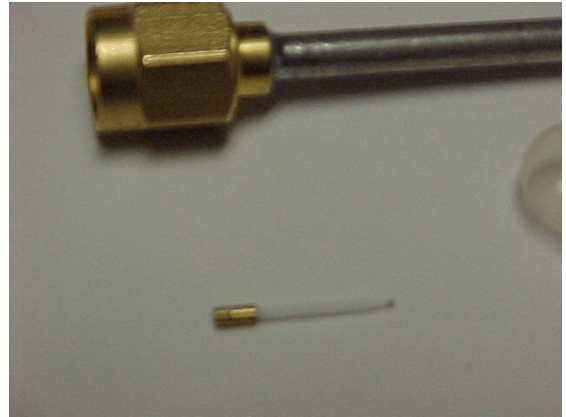

Fig II 9 : mounted YIG

Note that the 12 mil (0.012”) YIG sphere is mounted on a 30 mil ceramic (beryllium?) rod for thermal control, with a brass end for fixturing. 12 mil is about the width of an 0201 SMT component, or the length of an 01005!

The RLC resonator did not show a tuning response either.

Calculations were then performed to determine the magnetic field strength. From literature, it was found that YIG resonates at a frequency of 2.8 GHz per 1000 gauss. Cutting the coil of an identical transformer produced a shredded mess of wires, which couldn't be counted to determine the number of turns. So, the wire diameter was measured with a micrometer as 9.6 mils in diameter, and, from American Wire Gauge tables:

http://en.wikipedia.org/wiki/American_wire_gauge

... was determined to be 30 AWG and 103.2 Ω /1000 feet. From the 9.6 ohm measured resistance and estimated 2.25 inches per turn, an estimate of 491 turns was made. At 0.75 A, there were 368 ampere-turns.

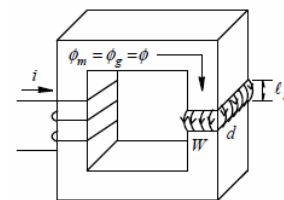

Magnetic structure with air gap.

Fig II 10 : mounted YIG

$$H_m l_m + H_g l_g = Ni = \phi \left(\frac{l_m}{A_m \mu_m} + \frac{l_g}{A_g \mu_g} \right)$$

$$Ni = 491 \times 0.75 = 368$$

$$= \phi \left(\frac{88.9 \times 10^{-3}}{0.0353 \times 10^{-3} \times 2000 \times 4\pi 10^{-7}} + \frac{3.175 \times 10^{-3}}{0.0353 \times 10^{-3} \times 4\pi 10^{-7}} \right)$$

$$\phi = 5.07 \times 10^{-6} \text{ Wb}; 5.07 \times 10^{-6} / 0.0353 \times 10^{-3} = 0.144 \text{ gauss (Wb/m}^2)$$

$$\ll 1000 \text{ gauss!}$$

Drawing, equations from First Course in Power Electronics, Ned Mohan 2007

The calculated result, four orders of magnitude below the desired magnetic field strength, seems too low. Manually checking the attraction with a piece of steel indicated somewhat similar field strength. There may be an error in the values or units used in the above equation, but none has been found.

To increase magnetic field strength, several steps can be taken. The number of ampere-turns can be increased, the core cross section can be increased and length decreased, and the air-gap cross section increased and length decreased.

III. SECOND IMPLEMENTATION OF RESONATOR – ELECTROMAGNET WITH IRON POLE PIECE

A. Commercial Electromagnet

An electromagnet # 5698K213 was ordered from McMaster-Carr

<http://www.mcmaster.com/#5698K213>

Although no manufacturer was named, the specifications match # R-1012-24 from Magnetech

<http://www.magnetechcorp.com/Round.htm>

| Part Number | Holding Value | Diameter | Height | Mounting Thread | Thread Depth | Lead Location | Lead Length | Watts | Amps | Net Weight |
|-------------|---------------|----------|--------|-----------------|--------------|---------------|-------------|-------|------|------------|
| 24 V. DC | 0" gap | A | B | C | D | E | | | | |
| R-1012-24 | 32 lb. | 1" | 1-1/4" | 10-32 | 1/2" | 3/16" | 24" | 3.6 | 0.15 | 3.3 oz. |

Table II 1 : Magnetech R-1012-24 specifications

No magnetic field strength was published for this part, but a similar one (1-1/4" diameter vs. 1") with a 5/8" center pole

quoted 250 Gauss at 4.32W consumption (0.72A @ 6V). Based on this, the R-1012-24 could be expected to produce 208 Gauss across the same area at 3.6W (0.15A @ 24V). By tapering the pole to a smaller area, higher field strength can be produced. What the specification doesn't address is the length of air gap; it may just strength of the field as it fringes to the concentric outer pole.

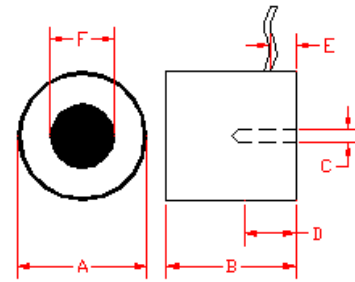

Fig II 11 : Magnetech Dimensions

| Part Number | Outer Diameter | Height | Mounting Thread | Thread Depth | Lead Location | Pole Diameter | Lead Length | Net Weight |
|-------------|----------------|--------|-----------------|--------------|---------------|---------------|-------------|------------|
| OP-1212 | A | B | C | D | E | F | G | |
| | 1-1/4" | 1-1/4" | 1/4-20 | 1/2" | 3/16" | 5/8" | 24" | 5.7 oz. |

Table II 2 : Magnetech OP-1212 specifications

| Applied Voltage | Current Draw | Average Flux Density (at surface) | Holding Value (at no gap) | Repelling Each Other (at 1/32" gap) | Applied Voltage |
|-------------------------|--------------|-----------------------------------|---------------------------|-------------------------------------|-------------------------|
| OP-1212 | Amps | Gausses | Lbs. | Lbs. | OP-1212 |
| 6 V.DC, 100% Duty Cycle | 0.72 | 250 | 1 | 0 | 6 V.DC, 100% Duty Cycle |
| 12 V.DC, 25% Duty Cycle | 1.5 | 450 | 4 | 0 | 12 V.DC, 25% Duty Cycle |
| 18 V.DC, 10% Duty Cycle | 2.2 | 750 | 8 | 0.2 | 18 V.DC, 10% Duty Cycle |
| 24 V.DC, 5% Duty Cycle | 2.9 | 1050 | 12 | 0.6 | 24 V.DC, 5% Duty Cycle |

Table II 3 : Magnetech OP-1212 performance

B. Pole Pieces

To make an adjustable pole piece, a 1/2" iron pipe cap was filed flat and an 8mm-1.25 threaded hole made in the end (additional holes were made for the insertion of the coax and mounted YIG sphere.) A nylon bushing was threaded to accept a cap screw and a set screw, also with holes for the other components. The screws were filed flat and tapered for a narrower gap. The screws were then adjusted to create a narrow gap and to be flush with the iron cap. The pole piece was then clamped to the electromagnet with a C-clamp.

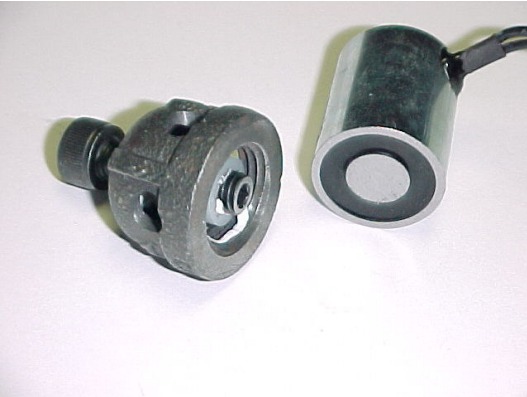

Fig II 12 : Homebrew vs. Commercial assembly

Photo from <http://www.vhfcomm.co.uk/pdf/A%20Simple%20Approach%20to%20YIG%20Oscil.pdf>

Compare home-brew pole pieces with the core and coil from a commercial YIG oscillator. Note fine wires to a small coil for fine-tuning frequency in real time, while the heavy wires provide “DC” bias of magnetic field.



Fig II 12 : Clamped Assembly

With the new electromagnet and pole piece, the resonator showed a peak that could be tuned from 1.8 GHz to 6 GHz. The lower limit may have come from the sphere itself; the magnitude of the amplitude peak decreased as frequency went down. There were multiple resonances observed due to parasitics in the coax fixture, so at some frequencies the “peak” was a flattening of the slope down from those resonances.



Fig II 12 : Electromagnet, ½” iron pipe and bolt pole piece, coax with ½ turn inductor at end, YIG sphere on rod (connected to wire for positioning) inserted in inductor

C. Measurement of Resonator

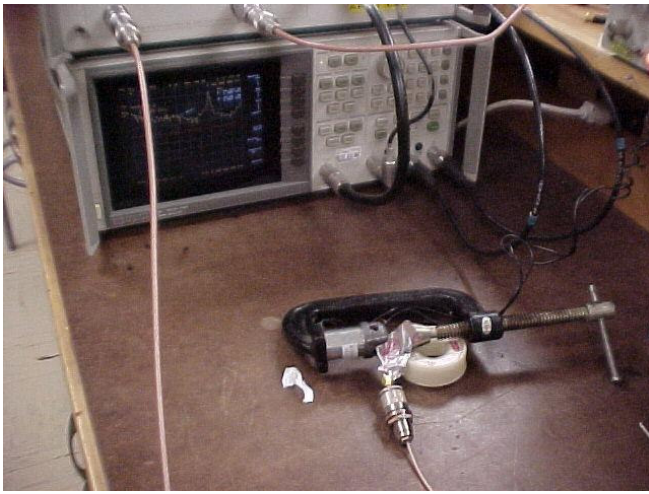
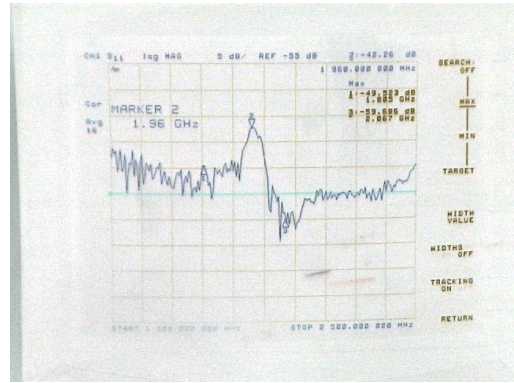
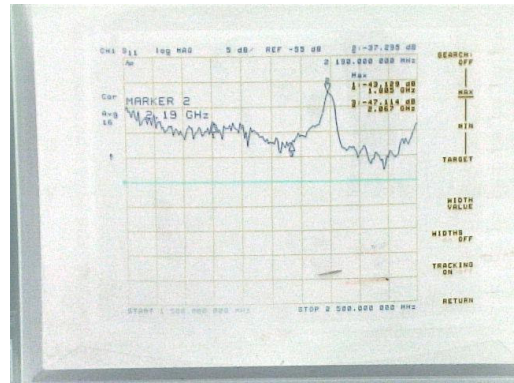

Fig II 12 : Test Setup

The following sequence of pictures was taken with the VNA frequency range set to 1.5 GHz to 2.5 GHz, and 5 dB/division.



IS111, RLC resonator, 1.96 GHz



IS111, RLC resonator, 2.19 GHz

The following sequence of pictures was taken with the VNA frequency range set to 1.8 GHz to 3.8 GHz, and 10 dB/division.

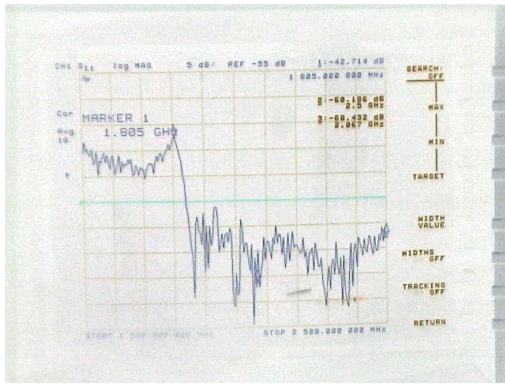

IS111, RLC resonator, 1.8095 GHz

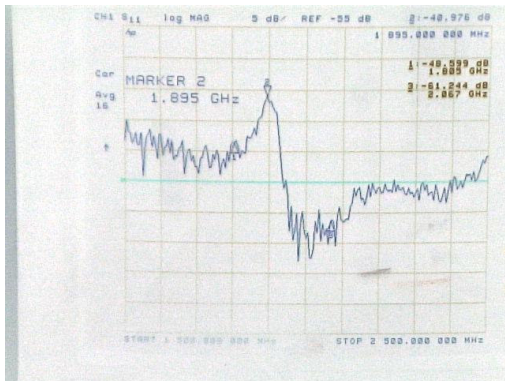

IS111, RLC resonator, 1.895 GHz

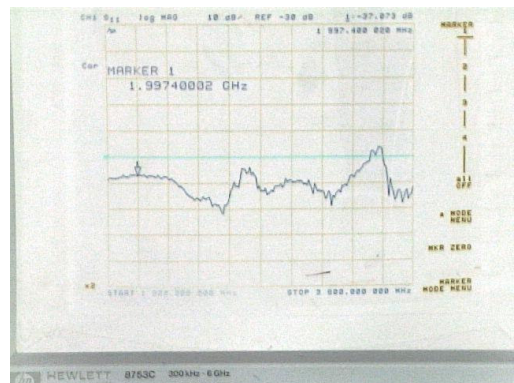

IS111, RLC resonator, 2.0 GHz

Note how the “peak” indicated is just a broad hump, compared to the following image.

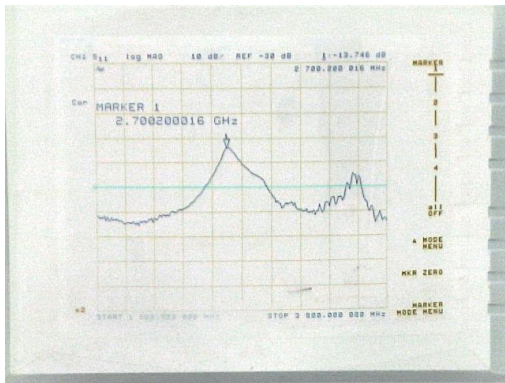

IS111, RLC resonator, 2.7 GHz

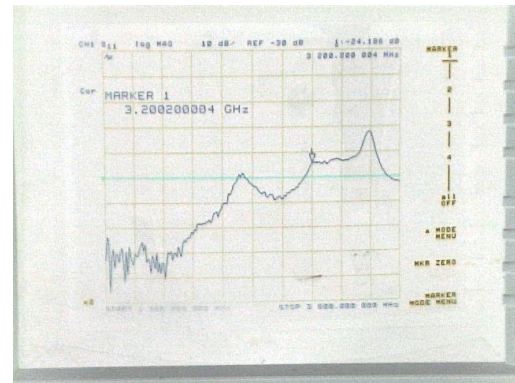

IS111, RLC resonator, 3.2 GHz

Note that the peak indicated is simply a leveling off of the slope down from the higher peak to the right.

It reached -24 dB, had been -35 dB when YIG tuned to higher frequency

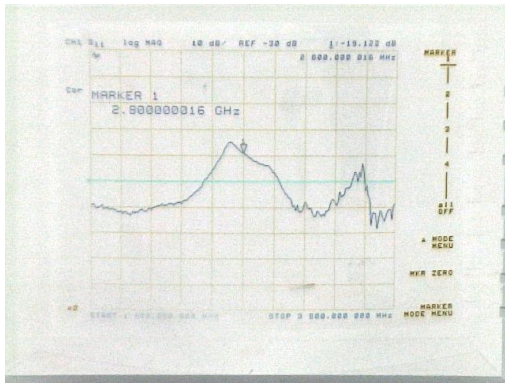

IS111, RLC resonator, 2.8 GHz

Note that the peak indicated is simply a slight inflection in the slope down from the higher peak to the left.

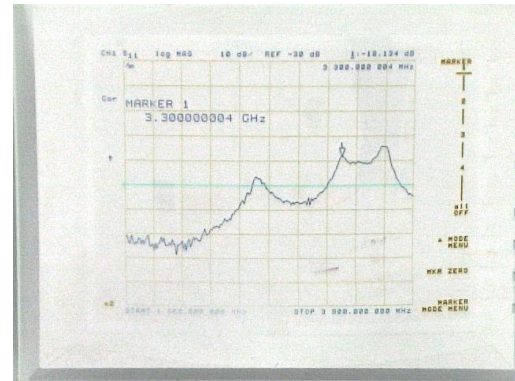

IS111, RLC resonator, 3.3 GHz

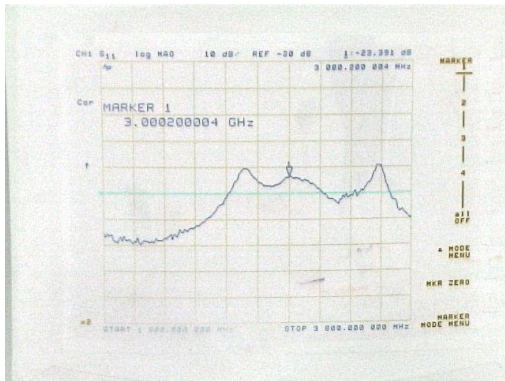

IS111, RLC resonator, 3.0 GHz

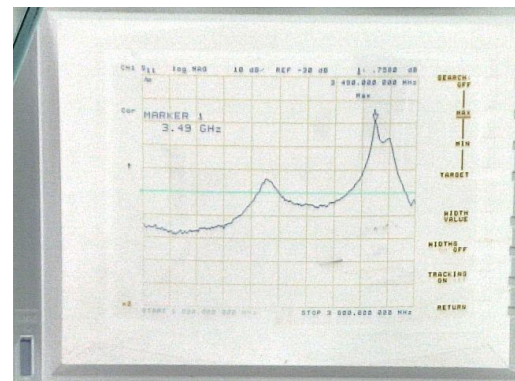

IS111, RLC resonator, 3.49 GHz

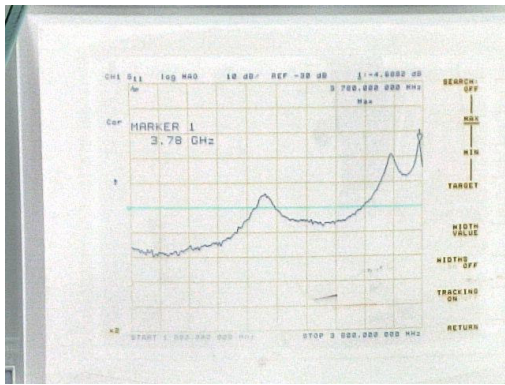

IS11, RLC resonator, 3.78 GHz

Note that the peak at 3.78 GHz is at -4 dB, compared to the same frequency being below -30 dB in the previous picture, when the peak was tuned to 3.49 GHz.

Next, the variation in phase was measured.

Note that because the resonator is at the end of a 50 ohm coax transmission line, there is a shift in phase vs. frequency, but changes to the impedance of the resonator alter the phase.

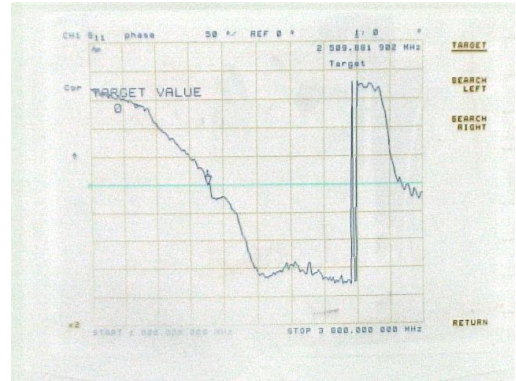

angle(S11), RLC resonator, crosses zero degrees at 2.5 GHz

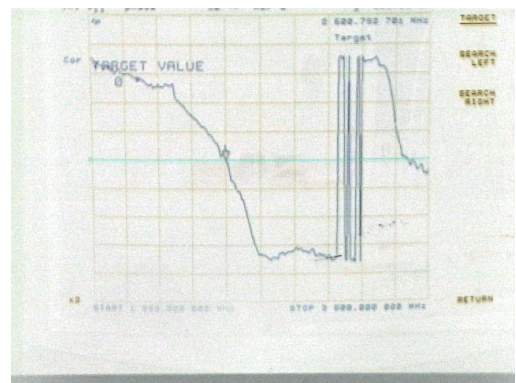

angle(S11), RLC resonator, crosses zero degrees at 2.6 GHz

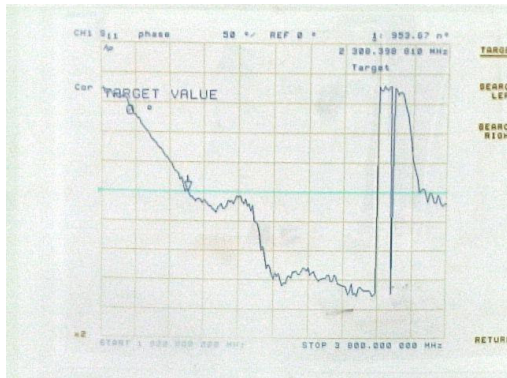

angle(S11), RLC resonator, crosses zero degrees at 2.3 GHz

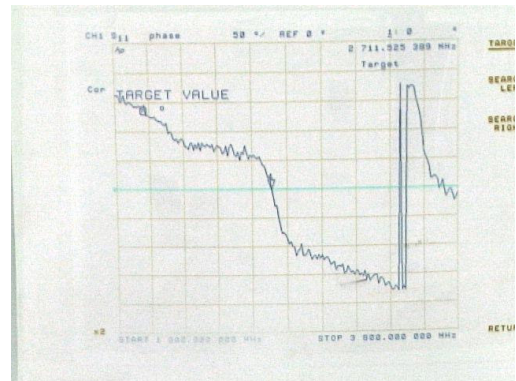

angle(S11), RLC resonator, crosses zero degrees at 2.7 GHz

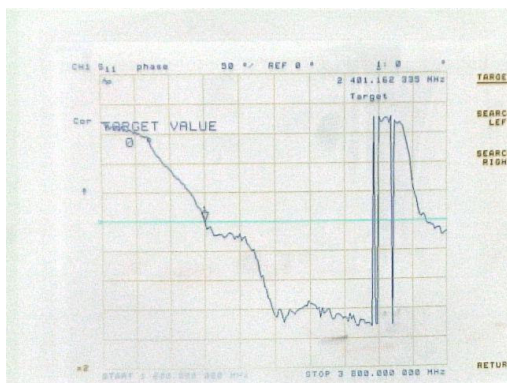

angle(S11), RLC resonator, crosses zero degrees at 2.4 GHz

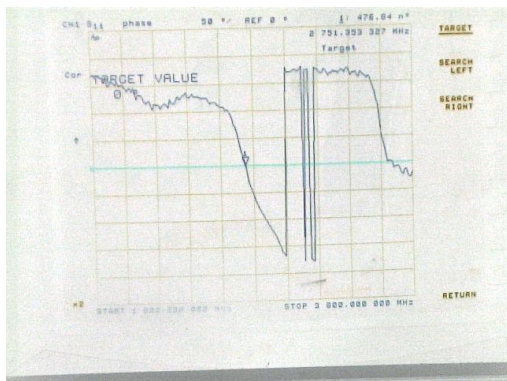

angle(S11), RLC resonator, crosses zero degrees at 2.75 GHz

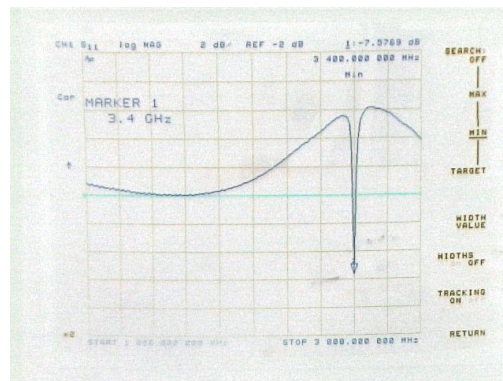

IS11, L resonator, 3.5 GHz

The resonator was then changed back to the original configuration (c), with just an inductor containing the YIG sphere, but no added capacitor or resistor.

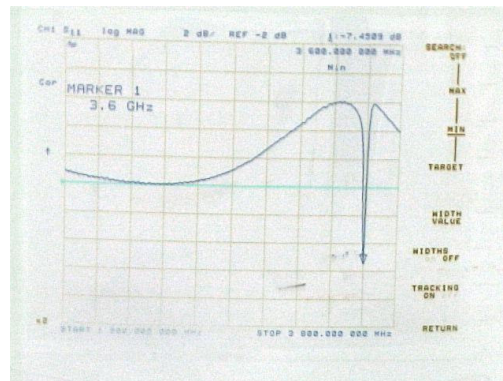

IS11, L resonator, 3.6 GHz

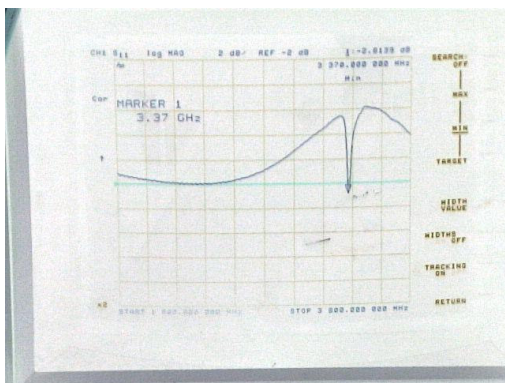

IS11, L resonator, 3.37 GHz

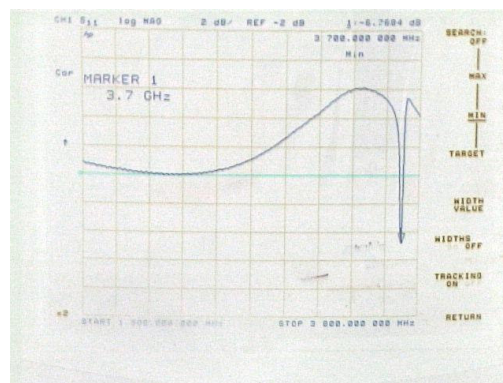

IS11, L resonator, 3.7 GHz

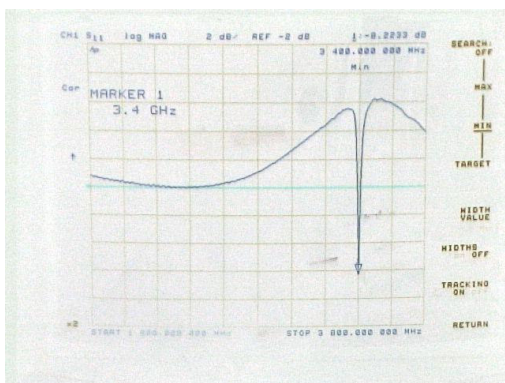

IS11, L resonator, 3.4 GHz

The amplitude response achieved with this configuration was typically a drop from +4 dB to -6 dB at the resonant frequency. Note that the positive dB figure represents an issue with calibration; these were passive circuits.

Tuning was relatively flat in terms of current vs. frequency, as shown in the following table. The deviation at lower

frequencies may be due to a less sharp peak, which couldn't be located as precisely.

| current (A) | Frequency (GHz) | GHz/A |
|-------------|-----------------|-------|
| 0.210 | 3.80 | 18.1 |
| 0.195 | 3.54 | 18.2 |
| 0.175 | 3.30 | 18.9 |
| 0.170 | 3.20 | 18.8 |
| 0.160 | 3.00 | 18.8 |
| 0.140 | 2.80 | 20.0 |
| 0.105 | 2.20 | 21.0 |
| 0.090 | 2.00 | 22.2 |

Table III 1 : YIG Ttuning Current

When the VNA frequency range was zoomed in to see the peak more closely, 3.3 to 3.9 GHz for a 3.6 GHz peak, it was observed the peak was drifting toward lower frequencies. This is not surprising because the coil was powered by a regulated voltage source rather than a current source, and as it warms up the increased coil resistance would reduce current flow and magnetic field strength.

D. Limitations and future plans

A full cal kit (open, short, 50 ohm termination) was not available for the SMA connector used in the resonator circuit. Calibration was attempted adding/removing adapters to connect the available calibration standards, which introduced errors. By calibrating again, telling the VNA that the LRC circuit at the end of a coax was the 50 ohm reference load, a somewhat flat response was achieved and peaks could be distinguished.

For future work a better physical configuration should be implemented, avoiding resonant peaks from parasitic L & C. A smaller loop, tightly around the sphere, should allow it to affect inductance more. Calibration to the end of a microstrip (or other transmission line) would allow measurement of the resonator alone, with the added frequency-dependent effect of the transmission line. The results would then represent a model of a resonator circuit to be simulated as part of an oscillator.

IV. SECOND IMPLEMENTATION OF AMPLIFIER

A. RF Amplifier

Objective for the YIG amplifier was to be able to achieve about a 20dB gain with a wide tuning range, about 2Ghz to 10Ghz while also achieving an S11 of less then -20dB. We wanted to achieve our above mentioned goals without using a wideband matching network.

B. Theory

For a system to oscillate and sustain oscillation transfer function must be:

$$\frac{V_o}{V_i} = \frac{A}{(1-BA)} \text{ (Equation 1).}$$

In the unstable condition $BA = 1$, hence the open loop gain of the circuit must be 1 while the phase be 0 or 360 degrees. In circuit design the negative resistance concept is used to design oscillators. A circuit will oscillate if no power is lost in any resistive path. Since in practice, a resistive path is always present, the amplifier is used to generate a negative resistance that is large enough to compensate for the power that is lost due to a resistive path.

The design was divided into 5 portions.

1. Choosing transistor and topology.
2. Rough design for DC operating points and biasing.
3. Implementation and simulation in Microwave Office.
4. Realization and bench characterization.
5. Implementation and simulation in Microwave Office with parasitic components.

C. Choosing the transistor topology

Not many transistors were available in the open market that had a $f_t > 5\text{GHz}$. Some transistors were found at Halted, NTE 164, yet those transistors were a larger package and had f_t of 4Ghz. Some transistors from digikey were also ordered, these included 2 Panasonic transistors 2SC4805 with an f_t of 8Ghz, since this was a surface mount component it was ideal for high frequencies. The measured I-V curves for 2SC4805 are shown in figure IV-1, and figure IV-2

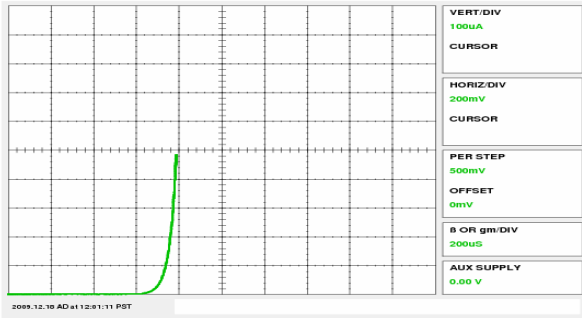

Figure IV-1 I_C vs. V_{BE}

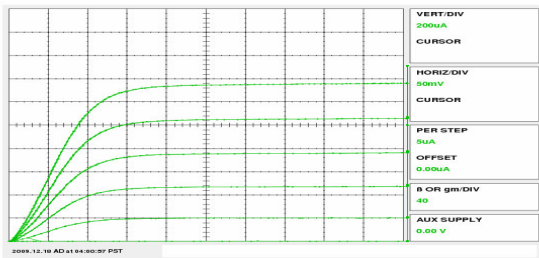

Figure IV-2 I_C vs. V_{CE}

A common base configuration for the amplifier design is used to provide a 0 degree phase shift, for the small input resistance and easier matching capability to the resonator.

D. Design for proper biasing

Figure IV-3 shows a rough design of the amplifier using OrCad, this is the circuit that was started with. The YIG amplifier section was designed to give a collector current of 15mA to get the highest transition frequency available for this transistor. Assuming a h_{fe} of 100 gives a base current of 150uA and emitter current equal to 14.85mA. A 300Ω resistor with a V_{CC} of 11.2V is chosen to give a DC operating point at the collector of 6V (V_C), gives enough dynamic range

and also does not damage the transistor which has an absolute maximum rating of 10V between collector and emitter. A second supply V_{BB} is used to bias the base portion of the transistor. With a base current of 150uA, the V_{BB} is set to 5.5V with a 22kΩ current limiting resistor. The base voltage is about 2.2V. A 100Ω emitter resistor is used on the emitter to provide a DC path and also to set a bias point on the emitter and the base.

$$I_C = 15\text{mA. (Equation 1)}$$

$$I_b = \frac{15\text{mA}}{100} = 150\text{uA. (Equation 2)}$$

$$I_e = \frac{100}{100+1}(15\text{mA}) = 14.85\text{mA. (Equation 3)}$$

$$V_C = 11.2 - (15\text{mA})(330\Omega) = 6.2\text{V (Equation 4)}$$

$$V_e = (100\Omega)(14.85\text{V}) = 1.485\text{V (Equation 5)}$$

$$V_b = 5.5\text{V} - (150\text{uA})(22\text{k}\Omega) = 2.2\text{V (Equation 6)}$$

$$g_m = \frac{15\text{mA}}{25.9\text{mV}} = 580\text{mA/V}$$

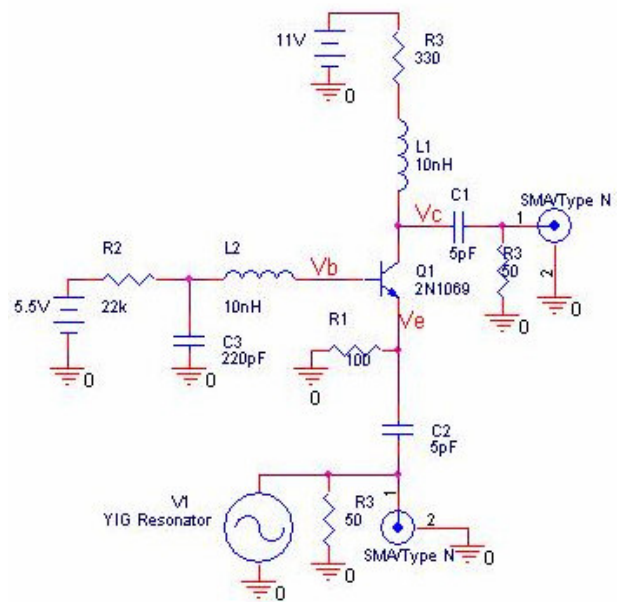

Figure IV-3

The amplifier will oscillate if a negative resistance is created with the inductive reactance between the base terminal and AC ground. The YIG resonator is added in the emitter. In the

design and simulation the YIG oscillator was modeled as an LC tank circuit.

The input impedance looking into the base is:

$$\frac{1}{j\omega C_{\pi}} + \frac{1}{j\omega C_2} - \frac{g_m}{\omega^2 C_{\pi} C_2}$$

The dynamic base resistance is ignored. In order to have negative resistance the sum of the first 2 terms must be less than the third term:

$$\frac{1}{j\omega C_{\pi}} + \frac{1}{j\omega C_2} < \frac{g_m}{\omega^2 C_{\pi} C_2}$$

The frequency of oscillation can be found by setting the magnitude of the imaginary part of the input resistance to zero.

$$f_{osc} = \frac{1}{2\pi} \sqrt{\frac{1}{LC_{\pi}} + \frac{1}{LC_2} + \frac{1}{LC_3}}$$

E. Simulation in Microwave Office

From the starting topology and design, the design was implemented in Microwave Office. Because of the limited components available in the Microwave Office library a transistor was chosen that was similar to what was going to be used to build the amplifier, an Infineon BRF360F with an ft of about 14Ghz and C_{π} of 200fF.

The schematic of the amplifier without any parasitic is shown in Figure X. This amplifier is optimized to provide the gain and reflection coefficient targeted. Note that a capacitor in parallel with C_{π} is added to monitor the affect it has on the design. Figure X+1 shows the simulation. We chose to tune L1, C4, R1, C5 and C2 for the bandwidth of the amplifier C4, C5, C2 for the gain and R3, C2, C5 for the reflection coefficients. Between 4.3Ghz and 4.7Ghz we were able to achieve an S21 of about 15dB and a S11 of -25dB and 3dB bandwidth of 500Mhz. If high gain is not necessary then the amplifier can work up to 5.1Ghz and while having an excellent S11.

In Figure X + 1 a simulation of an amplifier with a bandwidth of 2Ghz and a higher gain, however it is undesirable because of the high S11.

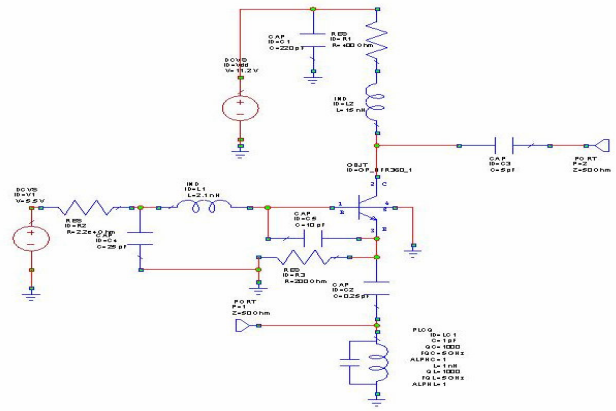

Figure IV-4 Simulation circuit

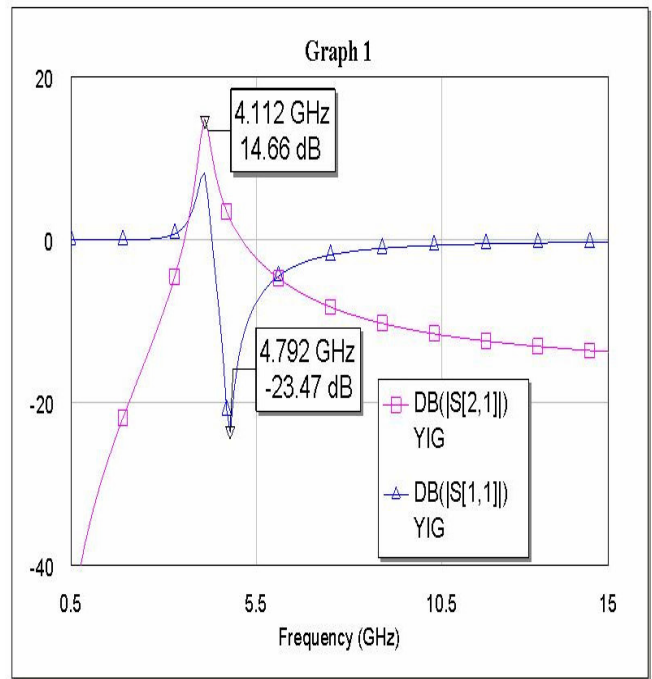

Figure IV-5. Gain and reflection of our design.

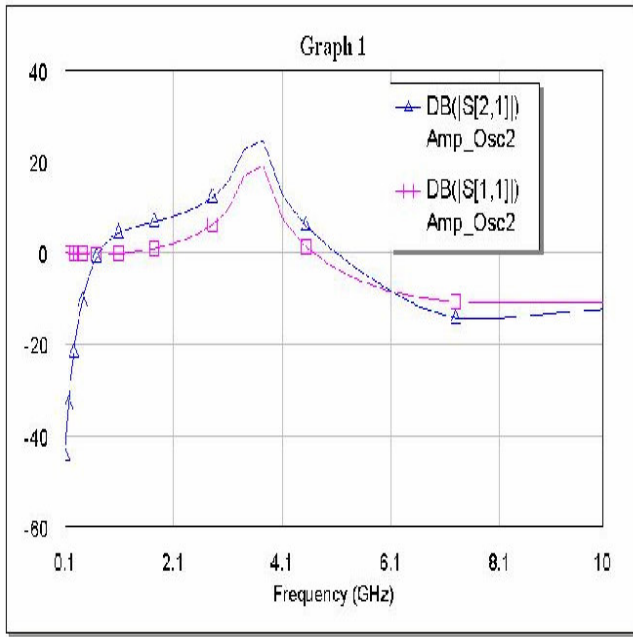

Figure IV-6. Simulation of a higher bandwidth amplifier design.

V. REALIZATION AND BENCH CHARACTERIZATION

A. Assembly and Components

A large bare copper board was used to build the YIG amplifier (Figure V-1 and Figure V-2). Two sites were used on the copper board, one with N-type connectors (Site 1) that were readily available and one with SMA connectors (Site 2) that were not readily available.

| Site 1 | Site 2 |
|-----------------------------------|-----------------------------------|
| N-type connectors | SMA connectors |
| 0805 Capacitors | 0805 Capacitors |
| Through-hole resistors | Through-hole resistors |
| Straight wire inductors | Straight wire inductors |
| Surface mount Bipolar transistors | Surface mount Bipolar transistors |
| Banana Jacks | Banana Jacks |

Table 1

The power supply was hooked to banana jacks with a twisted wire with separate ground cables. Both supplies were decoupled with extra decoupling in addition to the design that was simulated. Multiple de-coupling capacitors were used to limit the circuit resonating due to parasitic. Chip inductors were not available so 24 gauge wires were used as inductors. The inductance was modeled as 1nH/mm.

Site 1 was built with type-N connectors and a very small surface mount transistor the layout area of the YIG amplifier was increased and large parasitic inductances were added. A vector network analyzer and spectrum analyzer screen shot shows a signal present at 1.7Ghz. When the input was removed from the input of the amplifier the signal did not go away. The circuit was self-resonating from the long leads present in the layout. Site 1 circuit was simulated with parasitic components in Microwave office, with the resonator removed. The simulator confirmed a peak at 1.7Ghz as can be seen in figure.

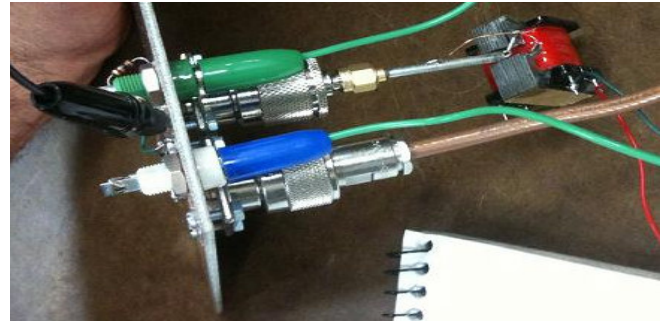

Figure V-1. Site 1 realization with Panasonic transistor.

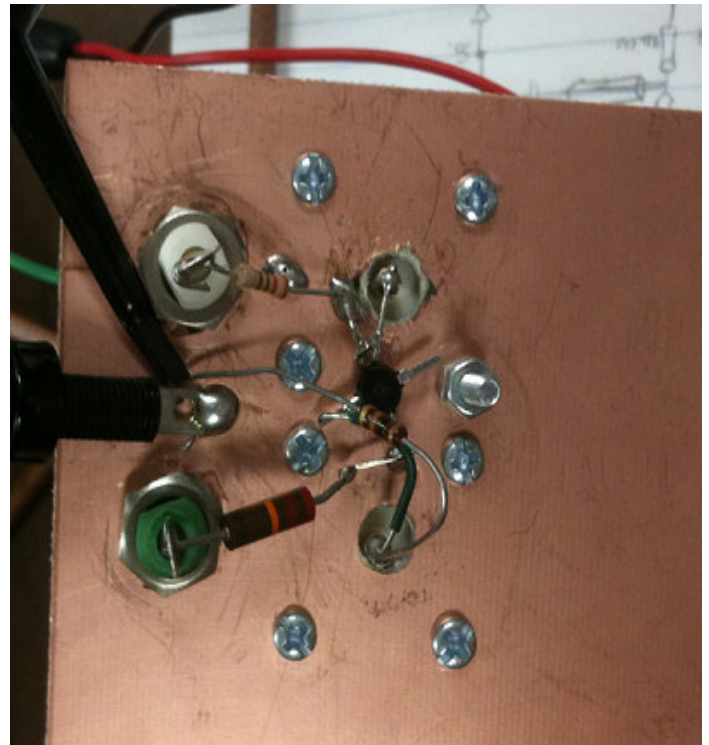

Figure V-2. Site 1 layout and realization with NTE 164.

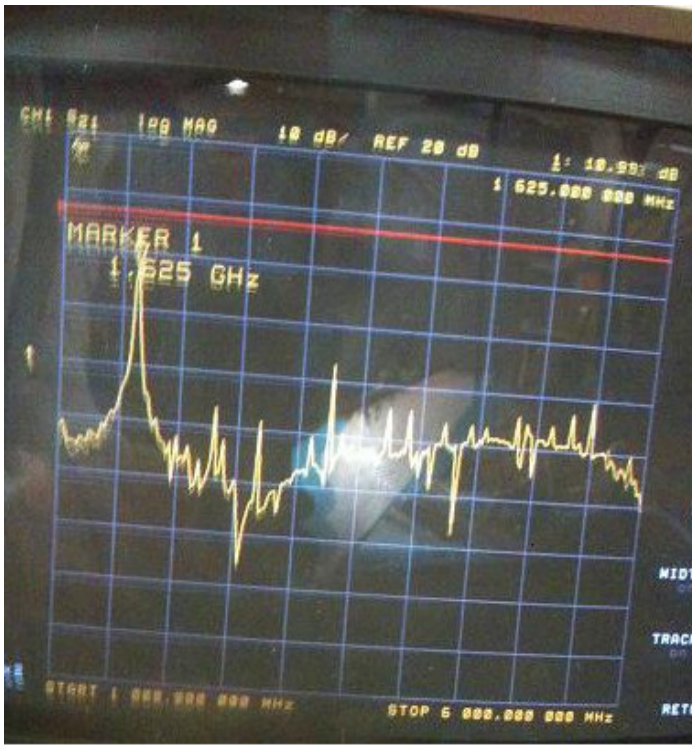

Figure V-3. Site 1. Output of the amplifier.

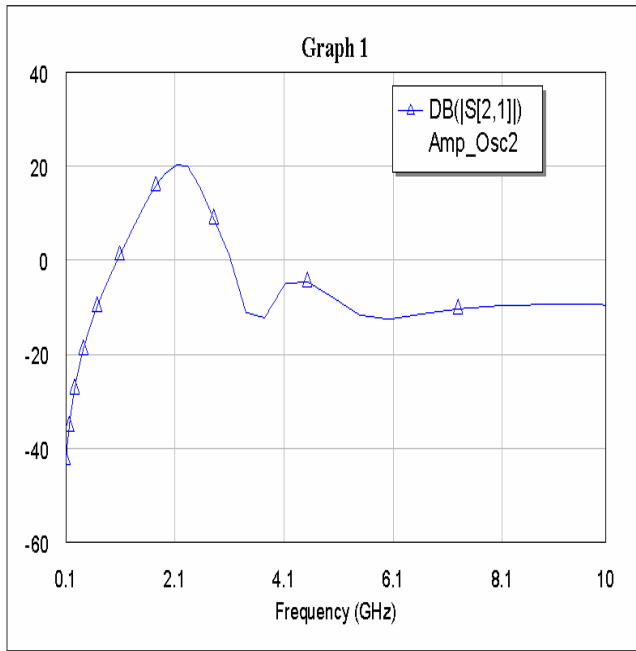

Figure V- 4

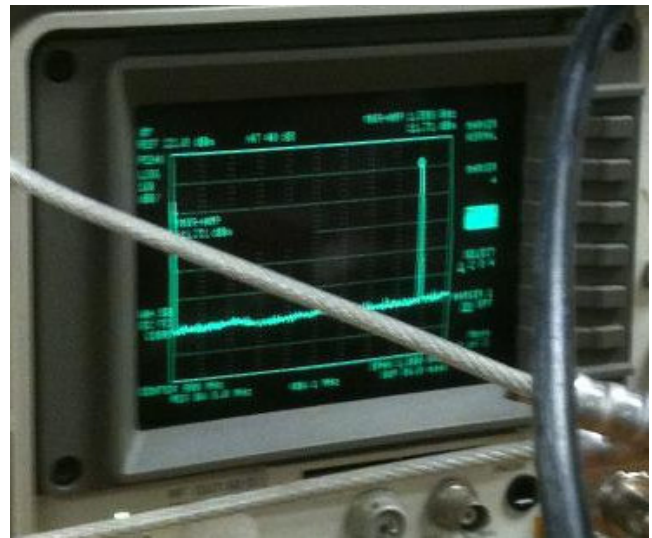

Figure V-5. Site 1. Output of the amplifier in Frequency domain.

Site 2 was built with SMA connectors and small surface mount transistors which gave a smaller layout and smaller parasitic inductance. The results can be seen in figure. Assembling the circuit onto the copper board was very challenging and



Figure V-6. Site 2. Output of amplifier.

IX. CONCLUSION

We had a great experience designing, building, and testing a YIG resonator and bipolar amplifier. While we didn't complete a tunable oscillator as originally planned, we had fun and learned a few things.

REFERENCES

- [1] Wikipedia, *American Wire Gauge* web page, http://en.wikipedia.org/wiki/American_wire_gauge
- [2] Microlambda Wireless, *YIG Tuned Oscillator* web page, <http://www.microlambdawireless.com/apppdfs/ytodefinitions2.pdf>
- [3] Microlambda Wireless, *YIG Tuned Filter* web page, <http://www.microlambdawireless.com/apppdfs/ytfdefinitions2.pdf>
- [4] VHF Communications, *A simple approach to YIG oscillators* web page, <http://www.vhfcomm.co.uk/pdf/A%20Simple%20Approach%20to%20YIG%20Oscil.pdf>
- [5] Teledyne Microwave, *A simple approach to YIG oscillators* web page, http://www.teledynemicrowave.com/Products/Oscillators/Ultra_Low_Phase_Noise_YIG_Oscillators.aspx
- [6] Mohan, Ned; *First Course on Power Electronics*, Year 2007 Edition, MNPERE, 2007
- [7] McMaster-Carr Corporation, <http://www.mcmaster.com/#5698K213>
- [8] Magnetech Corporation, <http://www.magnetechcorp.com/Round.htm>

